

POT	FUNCTION	REF
RV6	AUTO HOMING TIMER (10Sec to 4.0Min) Set to 1Min	E5
RV5	AUTO-RAMP RAISE (20 Sec to 4.5 Min)	D4
RV4	DOWN LIMIT OVER TRAVEL (1.0 Sec to 6.0 Sec)	D5
RV3	LIGHT TIMER (20 Sec to 4.5 min)	B5
RV2	GATE RELEASE TIMER (10 Sec to 30 Sec) - SET TO 15sec	C5
RV1	BATTERY CHARGING VOLTAGE - SET TO 27.5V	E6

LINK	FUNCTION	TO ENABLE FUNC	REF
LK1	Keyswitch Override - all call stations	Fit Link	(B6)
LK1	Keyswitch Override, Upper CS (interface PCB)	Fit Link	(C10)
LK2	Keyswitch Override, Lower CS (interface PCB)	Fit Link	(E10)
LK3	Charge Failure Alarm	Fit Link	(E6)
LK4	Auto Ramp Raise Disable	Remove Link	(E5)
LK5	Momentary Operation	Fit Link	(C5)
LK6	Bridging Plate Override (UP)	Fit Link	(C6)
LK7	Bridging Plate Override (DOWN)	Fit Link	(C6)
LK8	Platform Gate Interlock Override	Fit Link	(C5)
LK10	Platform Level Switch(Solder Link)	Remove Link	(G6)
LK11	Travel Alarm Down	Fit Link	(D4)
LK12	3Sec Timer(Momentary Operation)	Fit Link	(C4)
LK13	Upper Gate (Left Hand No Gate)	Fit Link	(B6)
LK13	Upper Gate (Right Hand Gate Fitted)	Fit Link	(B6)
LK14	Auto Homing Timer (Down)	Fit Link	(E4)

LED	FUNCTION	REF
LED.1	Control Voltage 27.5V	(E6)
LED.2	Stop Circuit	(D4)
LED.3	Gate Closed Interlock	(F5)
LED.4	Ramp Raised	(F4)
LED.5	Pump	(F6)
LED.6	Lowering Valve	(F6)
LED.7	Up Safety Circuit	(B6)
LED.8	Down Safety Circuit	(G5)
LED.9	Up Limit	(D5)
LED.10	Down Limit	(E5)
LED.11	Gate Release Trigger	(C5)
LED.12	Gate Release Timer	(C5)
LED.13	Upper Gate Solenoid	(D6)
LED.14	Down Limit Overtravel Timer	(G5)
LED.15	Ramp Sense Up	(G5)
LED.16	Ramp Sense Down	(G5)
LED.17	Auto-Ramp Raise Timer	(D4)

CON	FUNCTION	REF
CON1/1	W	GATE INTERLOCK UPPER
CON1/2	BK	LOCK SOL. UPPER GATE
CON1/3	B	GATE INTERLOCK UPPER
CON1/4	BN	LOCK SOL. UPPER GATE
CON1/5	S	BRIDGING PLATE (UP)
CON1/6	R	BRIDGING PLATE (DOWN)
CON1/7	V	CALL UP
CON1/8	P	CALL DOWN
CON1/9	O	COMMON
CON1/10	C	EMERGENCY STOP (COMMON)
CON1/11	G/Y	DOWN LIMIT (OV) COMMON
CON1/12	Y	DOWN LIMIT (N.C)
CON1/13	BK/W	DOWN LIMIT (N.O)
CON1/14	B/W	BRIDGING PLT (COM OV SW.)
CON1/15	BN/W	+24 VOLT LIGHTING

CON	FUNCTION	REF
CON2/1	W	GATE INTERLOCK UPPER
CON2/2	BK	LOCK SOL. UPPER GATE
CON2/3	B	GATE INTERLOCK UPPER
CON2/4	BN	LOCK SOL. UPPER GATE
CON2/5	S	BRIDGING PLATE (UP)
CON2/6	R	BRIDGING PLATE (DOWN)
CON2/7	V	CALL UP
CON2/8	P	CALL DOWN
CON2/9	O	COMMON
CON2/10	C	EMERGENCY STOP (COMMON)
CON2/11	G/Y	DOWN LIMIT (OV) COMMON
CON2/12	Y	DOWN LIMIT (N.C)
CON2/13	BK/W	DOWN LIMIT (N.O)
CON2/14	B/W	BRIDGING PLT (COM OV SW.)
CON2/15	BN/W	+24 VOLT LIGHTING

CON	FUNCTION	REF
CON3/1	W	GATE INTERLOCK UPPER
CON3/2	BK	LOCK SOL. UPPER GATE
CON3/3	B	GATE INTERLOCK UPPER
CON3/4	BN	LOCK SOL. UPPER GATE
CON3/5	S	BRIDGING PLATE (UP)
CON3/6	R	BRIDGING PLATE (DOWN)
CON3/7	V	CALL UP
CON3/8	P	CALL DOWN
CON3/9	O	COMMON
CON3/10	C	EMERGENCY STOP (COMMON)
CON3/11	G/Y	DOWN LIMIT (OV) COMMON
CON3/12	Y	DOWN LIMIT (N.C)
CON3/13	BK/W	DOWN LIMIT (N.O)
CON3/14	B/W	BRIDGING PLT (COM OV SW.)
CON3/15	BN/W	+24 VOLT LIGHTING

CON	FUNCTION	REF
CON4/1	W	GATE INTERLOCK UPPER
CON4/2	BK	LOCK SOL. UPPER GATE
CON4/3	B	GATE INTERLOCK UPPER
CON4/4	BN	LOCK SOL. UPPER GATE
CON4/5	S	BRIDGING PLATE (UP)
CON4/6	R	BRIDGING PLATE (DOWN)
CON4/7	V	CALL UP
CON4/8	P	CALL DOWN
CON4/9	O	COMMON
CON4/10	C	EMERGENCY STOP (COMMON)
CON4/11	G/Y	DOWN LIMIT (OV) COMMON
CON4/12	Y	DOWN LIMIT (N.C)
CON4/13	BK/W	DOWN LIMIT (N.O)
CON4/14	B/W	BRIDGING PLT (COM OV SW.)
CON4/15	BN/W	+24 VOLT LIGHTING

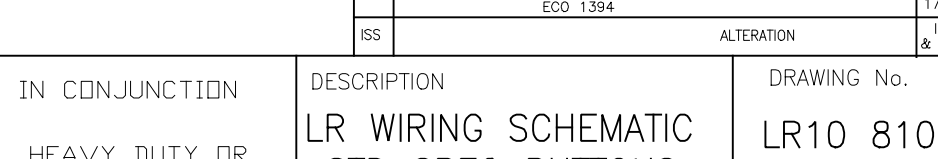
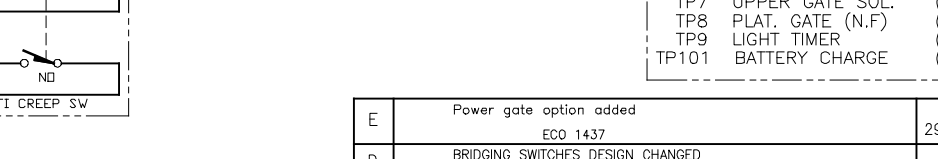
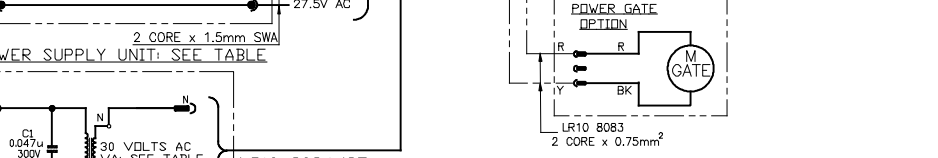
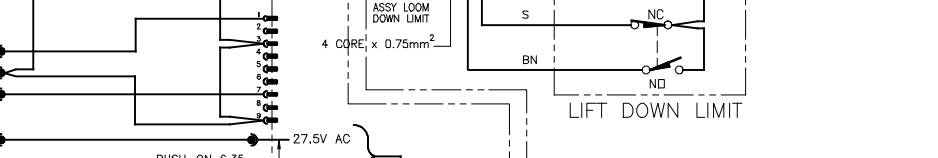
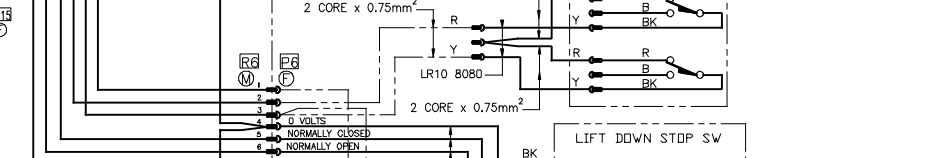
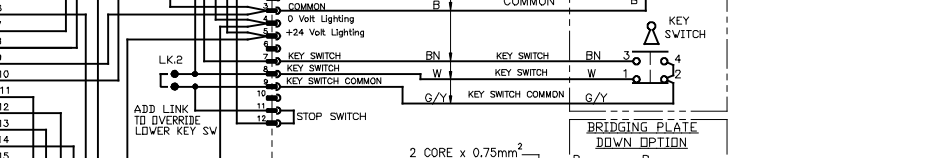
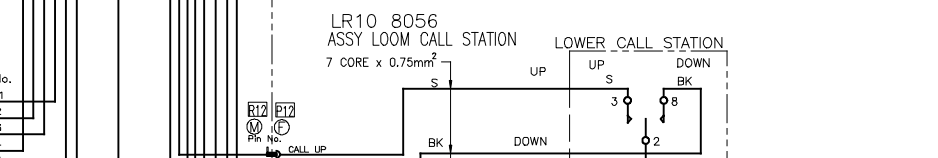
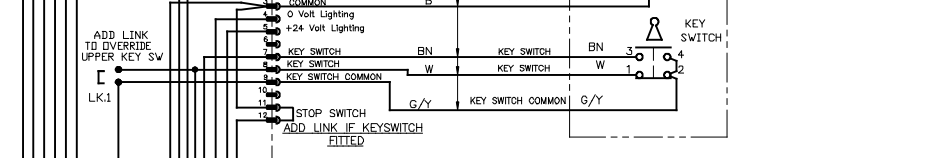
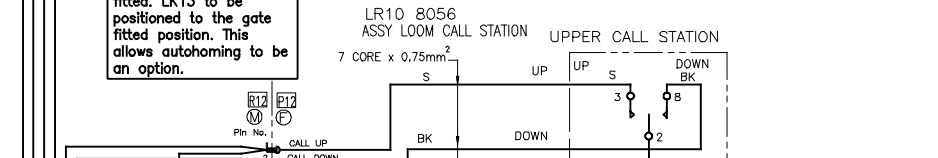
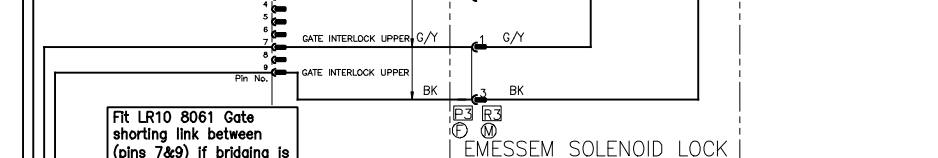
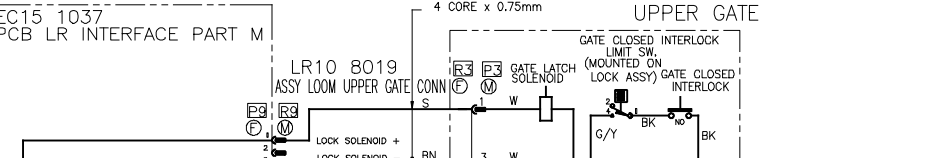
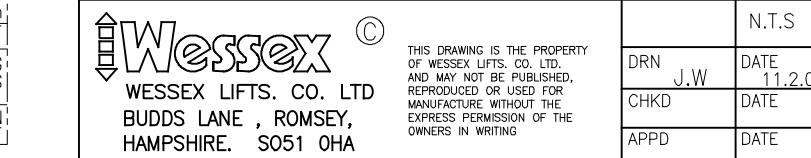
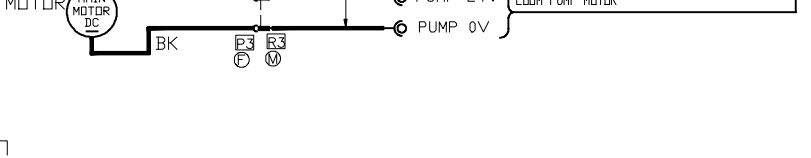
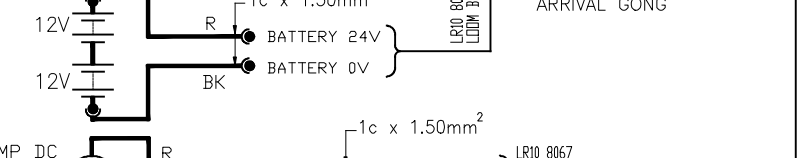
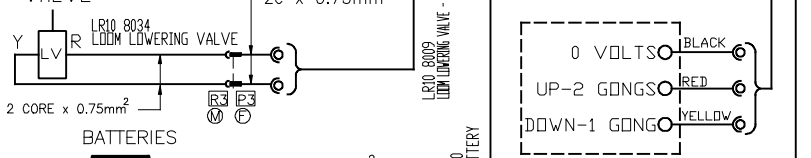
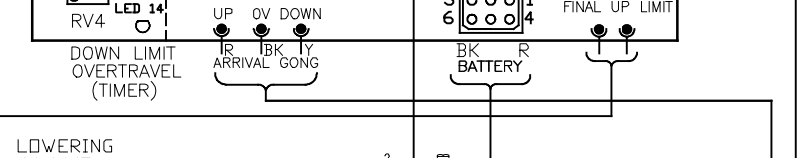
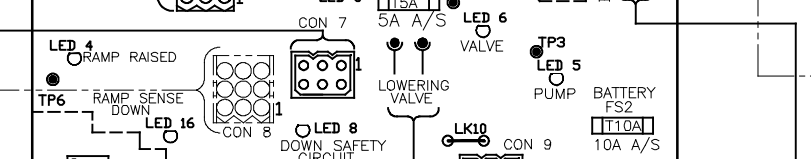
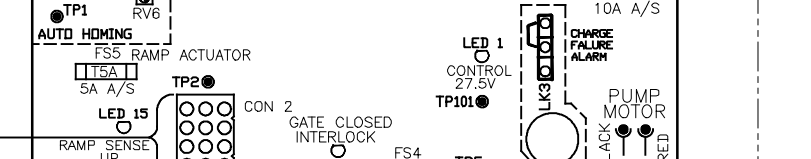
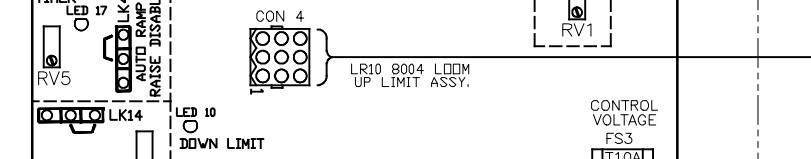
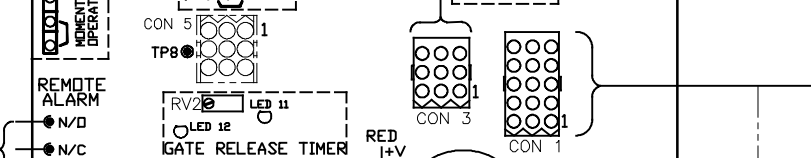
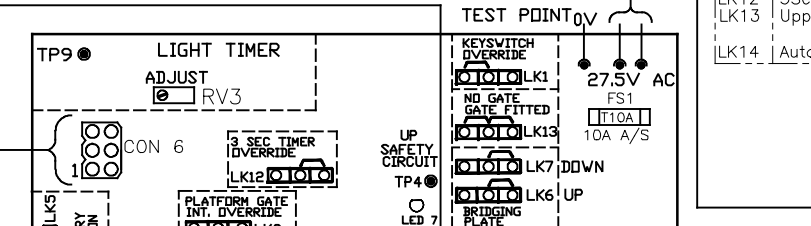
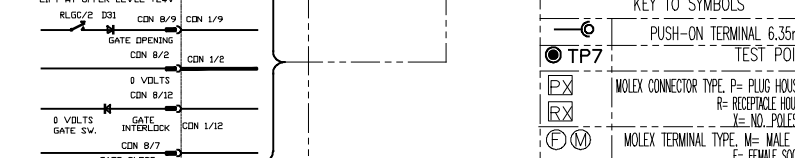
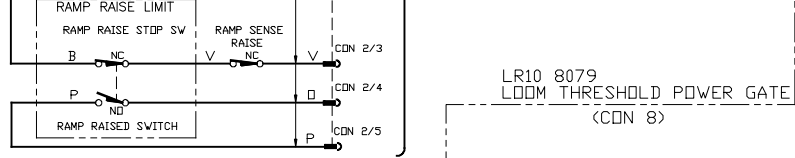
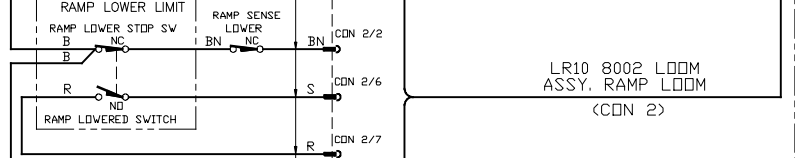
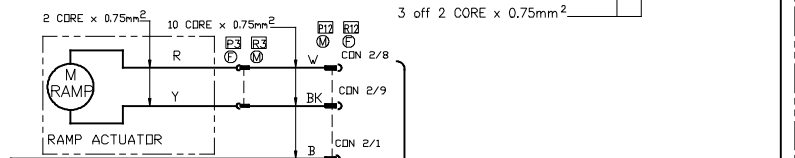
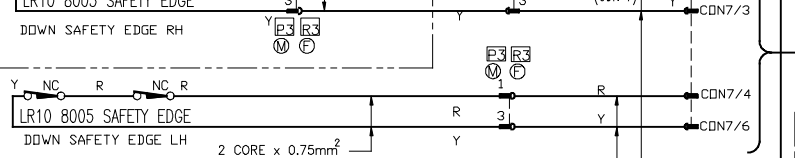
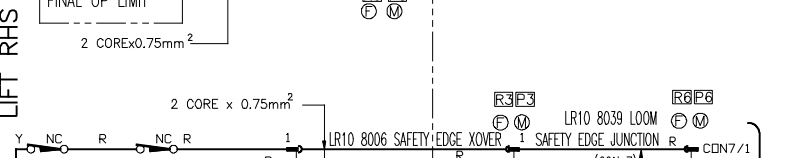
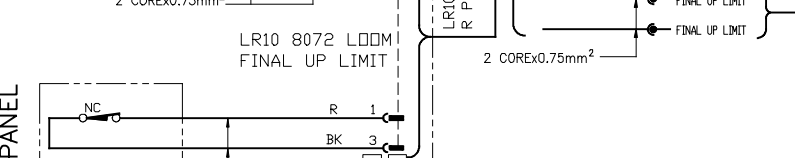
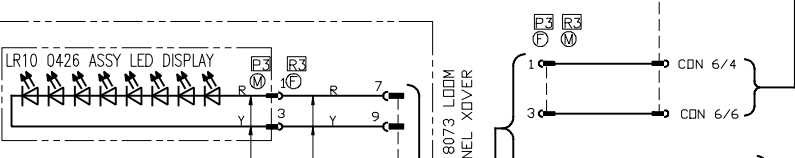
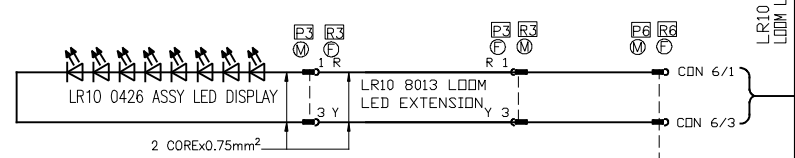
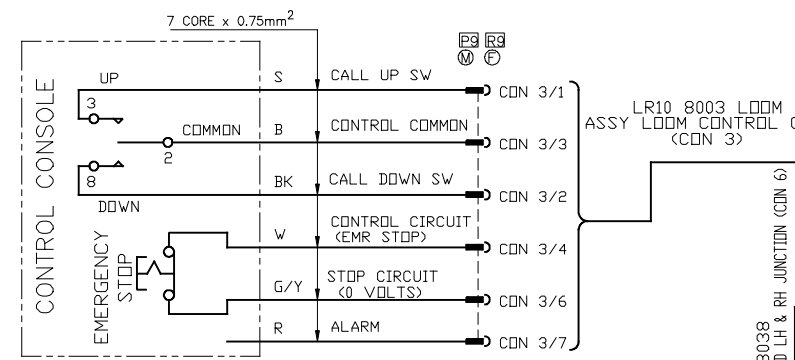

TEST POINT	FUNCTION	REF
TP1	RAMP ACTUATOR	(E4)
TP2	RAMP ACTUATOR	(F5)
TP3	PUMP RELAY	(F6)
TP4	OV. SWITCHED	(B6)
TP5	LOWERING VALVE	(F6)
TP6	OV. GATE SWITCHED	(F4)
TP7	UPPER GATE SOL.	(F6)
TP8	PLAT. GATE (N.F)	(C5)
TP9	LIGHT TIMER	(B5)
TP101	BATTERY CHARGE	(F6)

REV	DESCRIPTION	DATE	BY
E	Power gate option added	ECO 1437	WP
D	BRIDGING SWITCHES DESIGN CHANGED	ECO 1394	J.W
ISS			17.8.10

Wessex
 WESSEX LIFTS. CO. LTD
 BUDDS LANE, ROMSEY,
 HAMPSHIRE. SO51 0HA

DRN	DATE
J.W	11.2.03
CHKD	DATE
APPD	DATE

THIS DRAWING TO BE READ IN CONJUNCTION WITH DRG. No.S
 EC15 1038 PCB LR CONTROL HEAVY DUTY DR
 EC15 1040 PCB LR CONTROL STD DUTY

DESCRIPTION
 LR WIRING SCHEMATIC
 STD SPEC BUTTONS
 DRAWING No.
 LR10 8101
 SHEET 1 OF 1 SHTS